

环保注意事项和说明:

保护环境是每个社会成员的责任和义务。请您在使用本产品时,关注以下事宜。

1. 节能: 节能不仅是保护环境的需要,同时也可为您节省电费。
 - (1) 不观看液晶显示器时,请关闭电源开关(切断电源),以节约能源。
 - (2) 液晶显示器在待机状态下同样会消耗电能,若较长时间不使用显示器时,请尽可能关闭电源开关,不要使显示器长时间处于待机状态。
 - (3) 通过降低显示屏的亮度可降低显示器使用过程中的能耗。建议您根据使用环境选择低能耗的工作模式。如果您购买的显示器具有背光亮度调整功能,通过降低显示屏的背光亮度可有效降低电视机的能耗。

2. 环保使用期限和有害物质

- 产品及遥控器上的“环保使用期限”如左图所示。本产品及遥控器的“环保使用期限”为10年,电池等可更换部件环保使用期限可能与产品的环保使用期限不同。只有在在本使用说明书所述的正常环境下使用本产品时,“环保使用期限”才有效。

产品中有毒有害物质或元素的名称及含量:

部件名称	有毒有害物质或元素					
	铅 (Pb)	汞 (Hg)	镉 (Cd)	六价铬 Cr (VI)	多溴联苯 (PBB)	多溴二苯醚 (PBDE)
机芯	×	○	○	○	○	○
液晶屏	×	○	○	○	○	○
前壳	○	○	○	○	○	×
后壳	○	○	○	○	○	×
扬声器	○	○	○	○	○	○
金属结构件	○	○	○	○	○	○
附件	×	○	○	○	○	○

○: 表示该有毒有害物质在该部件所有均质材料中的含量均在 GB/T 26572-2011规定的限值要求以下。
 ×: 表示该有毒有害物质至少在该部件的某一均质材料中的含量超出 GB/T 26572-2011规定的限值要求。
 注1: 本产品应用环保设计理念,对有毒有害物质进行了有效控制,“X”表示的有毒有害物质或元素主要因技术发展水平限制,无法实现有毒有害物质或元素的替代。
 注2: 上述部件分类视具体产品有所不同,以实际产品为准。

* 本产品外壳阻燃性能等级低于2级。

3. 产品的回收和再利用

本产品采用有利于资源综合利用和无害化处理的设计方案,在现有技术情况下,尽可能采用了无毒无害(或低毒低害)以及便于回收利用的材料。本公司保证提供符合标准、满足环保要求的可更换部件,产品若需要维修或更换部件请与本公司售后服务部门联系。

产品废弃后,请不要随便丢弃,应送交国家认可有处理资格的企业进行回收处理。若需要了解产品废弃后回收的相关信息请与本公司售后服务部门联系。

4. 关于中国环境标志认证说明

显示器已列入中国环境标志认证,如果您购买的显示器或其包装上具有中国环境标志,说明该产品已经通过了中国环境标志认证。证明该产品不仅质量合格,且与同类产品相比,具有低毒少害、节约能源和资源、易于回收再利用和处置等优势,符合特定的环境保护要求,对生态环境更为有利。您可在环境保护部网站(<http://www.mep.gov.cn>)上浏览到关于环境标志的信息。

版本: 72-MS280G-S04AG

产品执行标准号:Q/MP2045-2011

产品标准备案号:QB/441300331907-2011

尊敬的客户:如在使用中遇到问题,请拨打TCL全国

统一用户服务热线4008-123456咨询

公司维修服务部地址请咨询4008-123456

TCL集团股份有限公司

地址:广东省惠州市仲恺高新技术开发区十九号小区

服务热线:4008-123456

传真:0752-2636307

邮编:516006

液晶显示器使用说明书

H46F3500G/H55F3500G/H65F3500G

COLOR YOUR WORLD



尊敬的客户,因本机功能较多,为了充分有效地应用各项功能,使用前,请您详细阅读本机使用说明书。

目录

简介/目录	01
主要随机附件	01
产品使用注意事项	02
本机功能及特色	03
外观图解及连接说明	04
遥控器说明	05
基本操作	05
菜单功能	05
设置	06
整机技术规格	07
故障分析及排除	08

主要随机附件

- ◆ 遥控器一个
- ◆ 说明书、保修卡等
- ◆ 电源线两根、视频转接线一根

产品使用注意事项:

1) 移动显示器的注意事项。

- 移动显示器时，请确认插头从电源插座上拔下并断开音频 / 视频连接线及任何固定绳的连接。
- 搬动显示器时，至少需要两个人。请务必直立搬动。
- 搬动显示器时，请勿使液晶屏幕面正面向上或向下。

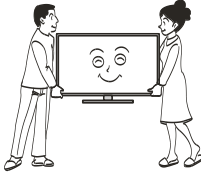

2) 请勿站在或攀爬到显示器上。

请有小孩的家庭特别注意勿让小孩攀爬到显示器上。请务必教育小孩，攀爬到放置台上触摸显示器控制面板等行为是危险的。



3) 显示器长期不使用时（例如外出度假或旅行），请从壁挂电源插座上拔下电源插头。

即使显示器处于待机状态，此时显示器并未实现与电源完全断开连接，所以仍然会消耗微量的电流。

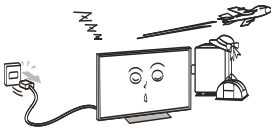

4) 打雷或闪电时，请勿触摸电源线或其他已连接的电线电缆。

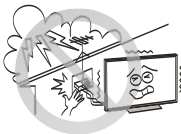

5) 请勿擅自维修、改装或拆卸显示器。请让维修技术人员检查和修理。



6) 显示器发生故障、冒烟或发出异味时，请立即关闭显示器，并从插座上拔下电源插头。

确认烟雾和异味已消失后，请联系维修技术人员。

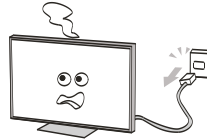

7) 如果显示器坠落或外壳损坏，请立即关闭显示器，并从插座上拔下电源插头。

请联络维修技术人员进行检查和维修。



8) 清洁前请拔掉电源插头。

请勿使用汽油或稀释剂等溶剂来清洁显示器。

- 这些溶剂可能会使外壳变形或漆面受损。
- 如果橡胶或乙烯基制品与显示器长期接触，可能会留下污迹。

如果外壳变脏，请用柔软干布擦拭。

清洁液晶显示屏的表面时，请用柔软的干布轻轻擦拭液晶屏幕表面。



本机功能及特色

本机功能

液晶显示器

- ① 中英文菜单
- ② 全功能红外线遥控
- ③ AV（视频）、YPbPr（分量）、PC（电脑）及数字 HDMI、USB接口
- ④ 支持SDTV及HDTV模式（480i/480p、576i/576p、720p、1080i/1080p）
- ⑤ 智能音量
- ⑥ 多种声音效果模式
- ⑦ 具有壁挂、桌面声音场景选择
- ⑧ 运动补偿功能（部分机型无此功能）

电脑显示器功能

- ① 提供大屏幕显示，高分辨率以及极好的彩色精确度
- ② 提供动态的显示区域，自动调整大小、自动居中，以及完美的几何图形
- ③ 支持电脑音源接入
- ④ 支持多种电脑显示格式，并有自适应显示功能

本机特色

- ① 自然光技术，更节能护眼
- ② 设备自动识别技术，信源切换更智能、自动化
- ③ 多种画质处理技术应用：3D亮色分离、动态对比度、彩色边缘改善，使画面更清晰亮丽

外观图解及连接说明

说明书中所有图示均为示意图，请以实物为准。

正面示意图 (以H46F3500G为例)

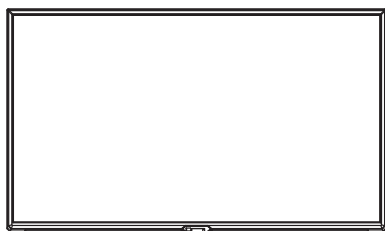

遥控接收窗/遥控指示灯

功能按键的介绍

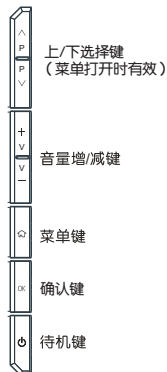

背面示意图 (以H46F3500G为例)

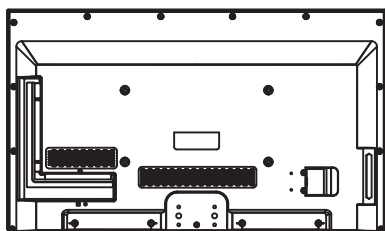

侧AV端子下示意图

- 1 音/视频输出：把音/视频信号连接到其它设备的音/视频输入端口
- 2 AV2/YPbPr输入：将分量信号源（DVD、镭射影碟机、录像机或摄影机等）连接至分量信号输入端口，将音频、视频输入信号连接到音/视频2输入端口。（注：AV2输入和YPbPr输入，共用音频输入端口，视频为YPbPr输入的Pr端口。）
- 3 电脑输入：用VGA信号连接至电脑主机上
注：在PC信源下，其音频输入共用YPbPr输入的音频输入端口

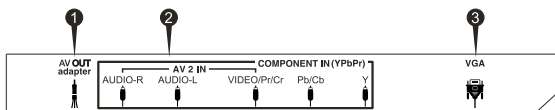

侧A V端子右示意图

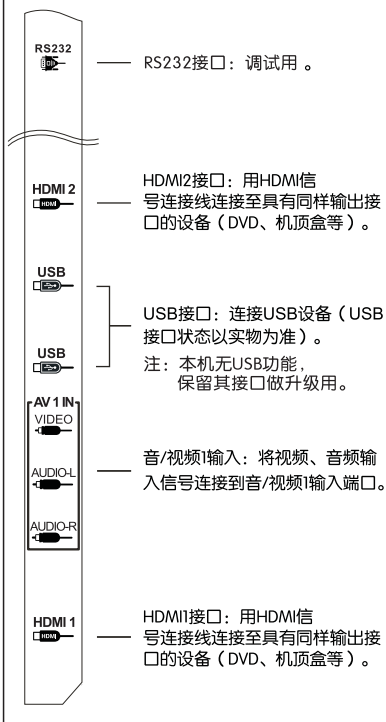

遥控器说明

遥控器图解（此为示意图，具体以实物为准）

遥控器的使用请注意以下事项：

- 1 打开遥控器背面的电池盒盖，然后按电池盒内所标注的极性相应放入两节7号电池，最后把电池盒盖盖上。
- 2 请将遥控器对准主机前壳上的遥控接收窗。若主机与遥控器之间有障碍物，遥控可能会失灵。
- 3 为确保遥控器良好的操作性能，如发现操作不正常，请立即更换电池。
- 4 不要将新、旧电池或不同型号的电池混合使用。
- 5 电池电力微弱时会发生泄漏电解液现象，这会损坏遥控器。一旦发现电力微弱，应尽快更换电池。
- 6 若长期不使用遥控器，请把电池取出，以免电池泄漏电解液。
- 7 电池不得暴露于诸如日照、火烤或类似过热环境中。

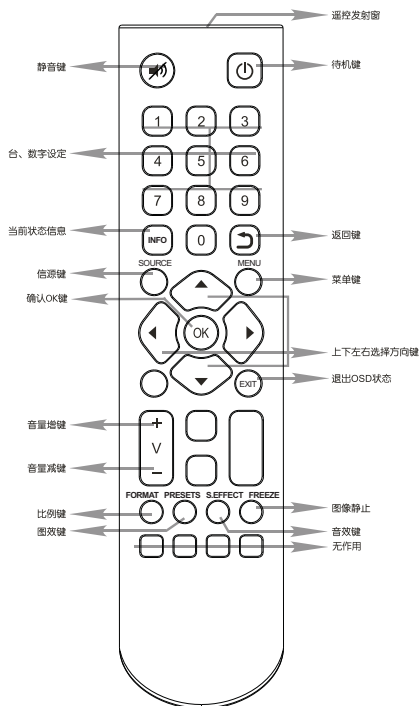

基本操作

连接电源

将显示器连接至交流电源插座。

开机

接 100V-240V 电源，打开显示器。在待机状态下按下遥控器上或显示器的待机键，显示器进入开机状态；在开机状态下按下遥控器上或显示器上的待机键，显示器进入待机状态。

关机

按遥控器或显示器上的待机键，此时，显示器进入待机状态。

注：如果长时间不使用本机，请将交流电源线插头拔出插座；若是停电，请及时将交流电源插头拔出插座，避免来电时使显示器直接开机。

菜单功能

本机型使用一个屏幕菜单系统来引导您进行操作，下面介绍如何用遥控器的相应按钮来操作屏幕菜单系统以达到您满意的视听效果。

主菜单

按“菜单”键，进入主菜单，包含：设置。

1、设置

子菜单内容：图像设置、声音设置、功能设置、系统信息、自动演示、几何设置；按左/右键在子菜单项中切换，按“OK”键进入选中项所对应的子菜单列表中，按菜单键退出主菜单。

图像设置

图像模式

按遥控器上的“OK”键进入图像模式选项列表，选项包括明亮、标准、柔和、自设；按左/右键选择选项，按“OK”键确认。当选择图像模式时，将图像模式选项列在屏幕下方，方便用户调节。

背光调节范围：0~100。

亮度调节范围：0~100。

对比度调节范围：0~100。

色度调节范围：0~100。（PC信源下不可选）

锐度调节范围：0~100。（PC信源下不可选）

色调调节范围：0~100。（仅在N制图像下有效）

色温选项：冷色、暖色、标准。

自然光选项：开、关。

动态对比度选项：开、关。

比例模式选项：标准、全屏、放大、拉伸、电影、字幕、全景、点对点，部分比例模式会在某些信源下灰掉不可选。



声音设置

按遥控器上的“OK”键或右键进入音效选项列表。

智能音效：音乐厅、影院、新闻、标准。

平衡调节范围：-50~+50

智能音量选项：开、关。

声音场景选项：壁挂、桌面模式。

功能设置

1、自选通

按遥控器上的“OK”键或右键进入自选通。

选项：关、自动接通、手动接通。

注：此功能不适用于AV2信源

2、运动补偿（部分机型无此功能）

按遥控器上的“OK”键或右键进入运动补偿选项列表。

选项：开、关。

3、开机画面（部分机型无此功能）

按遥控器上的“OK”键进入开机画面子菜单，按上/下键选择菜单。

开机画面选项：默认、画面1、画面2。

4、开机音乐

按遥控器上的“OK”键进入开机音乐子菜单，按上/下键选择菜单。

开机音乐选项：默认、音乐1、关。

5、语言

按遥控器上的“OK”键进入语言子菜单，按上/下键选择菜单。

语言选项：中文、英文。

6、睡眠定时

按遥控器上的“OK”键进入睡眠定时子菜单，按上/下键选择菜单。

睡眠时间选项：关、5分钟、10分钟、20分钟、30分钟、45分钟、60分钟、90分钟、120分钟。

7、定时关机

当前时间：按OK键开始输入，屏幕上相应位置出现数字输入软键盘，按左/右键选择数字，按OK键确认输入，按删除按钮删除已输入的字符，当输入完成后，按软键盘上完成按钮保存输入框内的数字，保存完成，软键盘消失。

关机类型：一次、每天、关。

关机时间：按OK键开始输入，屏幕上相应位置出现数字输入软键盘，按左/右键选择数字，按OK键确认输入，按删除按钮删除已输入的字符，当输入完成后，按软键盘上完成按钮保存输入框内的数字，保存完成，软键盘消失。

注：采用定时关机功能时因停电需要重新设置。

8、软件升级

按遥控器上的“OK”键进入软件升级，再次按“OK”键USB升级，软件升级文件成功搜索后，系统自动开始软件升级。

9、恢复出厂设置

按遥控器上的“OK”键进入，选择是否恢复出厂设置。

10、无信号待机

无信号待机选项：开，关

系统信息

按遥控器上的“OK”键进入系统界面：显示（显示用户ID和软件版本）。

自动演示

按左/右键移动至选项，按OK键执行。

色彩自然：独立色域分析、独立色饱和度分析、肤色校正分析、颜色绚丽分析；每个部分自动控制，一个模块分析完成后自动转入下一模块分析过程。

层次自然：锐度分析、独立锐度分析、行场方向锐度分析。

光线自然：光线自然分析。

分辨自然：3D降噪分析、空间降噪分析。

几何设置（仅在电脑信源下有效）

按遥控器上的上/下键可以选择自动调整、水平位置、垂直位置、采样时钟、相位调整，按OK键选择要调节选项，按左/右键调节。

整机技术规格

整机技术规格	H65F3500G	H46F3500G	H55F3500G
① 伴音输出功率：左+右音箱	8W+8W	8W+8W	8W+8W
② 工作电压：	100V~240V~ 50/60Hz	100V~240V~ 50/60Hz	100V~240V~ 50/60Hz
③ 最大工作电流：	2.3A	1.3A	1.4A
④ 可视图像对角线尺寸：	约164cm	约117cm	约139cm
⑤ 主机（不带底座）尺寸 （宽×高×厚mm）：	1470×864×54.1	1058.7×627.7×56.5	1250×735×59.2
⑥ 主机质量（不带底座）(kg)：	约33.5	约14.4	约20
⑦ 环境：工作温度0~40℃，工作相对湿度20%~80%（非冷凝），存储温度-20~60℃， 存储相对湿度20%~80%（非冷凝）；			
⑧ 状态显示方式：屏幕显示			
⑨ 调整状态指示：屏幕视窗菜单			
⑩ AV音频接口（输入）：10kΩ，0.5Vrms			
⑪ AV音频接口（输出）：10kΩ，0.3Vrms			
⑫ 屏幕显示语种：中文、英文			
⑬ AV视频接口（输入）：75Ω，1.0Vp-p，RCA 端子			
⑭ AV视频接口（输出）：75Ω，1.0Vp-p，RCA 端子			

故障分析及排除

无图像无伴音

家中保险丝、断路器不正常。
电源插座开关没打开。
电源线路接触不良。
检查信号源。

遥控器不能操作

需要更换电池。
电池的极性安装不正确。
主机电源没接通。

图像正常，无伴音

可能音量没打开，按音量加键。
有可能信号源出现故障。

无彩色

调节色度。
是否为黑白信号。

无图像，有伴音

调整亮度、对比度模拟量。
有可能信号源出现故障。
确认是否在单独听状态下。

电脑模式下黑屏

（即做电脑显示器使用时）
可能是由于电脑所设置的分辨率无法识别，建议更改为最佳分辨率或其他WINDOWS系统标准分辨率。

TCL

The Creative Life

**LCD MONITOR
OPERATION MANUAL**

H46F3500G/H55F3500G/H65F3500G

COLOR YOUR WORLD

The image features three stylized water splashes, each rendered with a complex, low-poly geometric pattern in shades of gray and black. The splashes are positioned in the lower half of the page, with one at the bottom left, one in the middle right, and one at the top right, creating a sense of dynamic movement.

IMPORTANT SAFETY INSTRUCTION

- 1) Read these instructions.
- 2) Keep these instructions.
- 3) Heed all warnings.
- 4) Follow all instructions.
- 5) Do not use this apparatus near water.
- 6) Clean only with dry cloth.
- 7) Do not block any ventilation openings. Install in accordance with the manufacturer's instructions.
- 8) Do not install near any heat sources such as radiators, heat registers, Stoves, or other apparatus (including amplifiers) that product heat.
- 9) Do not defeat the purpose of the polarized or grounding type plug. A polarized plug has two blades with one wider than the other. A grounding type plug has two blades and a third grounding prong. The wide blade or the third prong are provided for your safety. If the provided plug does not fit into your outlet, consult an electrician for replacement of the obsolete outlet.
- 10) Protect the power cord from being walked on or pinched particularly at plugs, convenience receptacles, and the point where the exit from the apparatus.
- 11) Only use the attachments/accessories specified by the manufacturer.
- 12) Use only with the cart, stand, tripod, bracket, or table specified by the manufacturer, or sold with the apparatus. When a cart is used, use caution when moving the cart/apparatus combination to avoid injury from tip-over. 
- 13) Unplug this apparatus during lightning storms or when unused for long periods of time.
- 14) Refer all servicing to qualified service personnel. Servicing is required when the apparatus has been damaged in any way such as power supply cord or plug is damaged, liquid has been spilled or objects have fallen into the apparatus, the apparatus has been exposed to rain or moisture, does not operate normally or has been dropped.
- 15) Warning to reduce the risk of fire or electric shock, do not expose this apparatus to rain or moisture. The apparatus shall not be exposed to dripping or splashing and that no objects filled with liquids, such as vases, shall not be placed on the apparatus.
- 16) Warning: the mains plug is used as disconnect device, the disconnect device shall remain readily operable.
- 17) Do not block any ventilation openings. Leave an open space around the equipment. Never place the equipment on a bed, sofa, rug, or any other similar surface. Do not place apparatus too close to drapes/curtains/walls, or in a bookcase, built-in cabinet, or any other similar places that may cause poor ventilation.

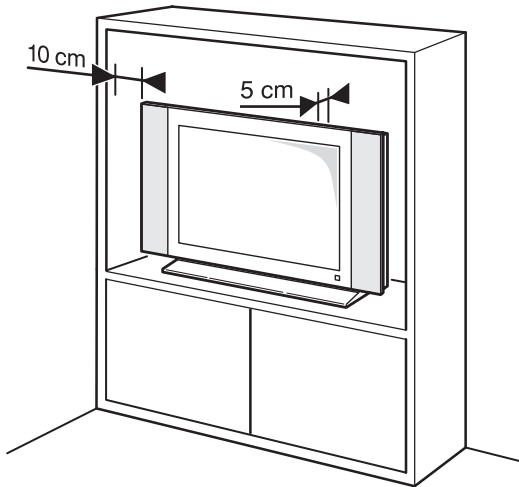
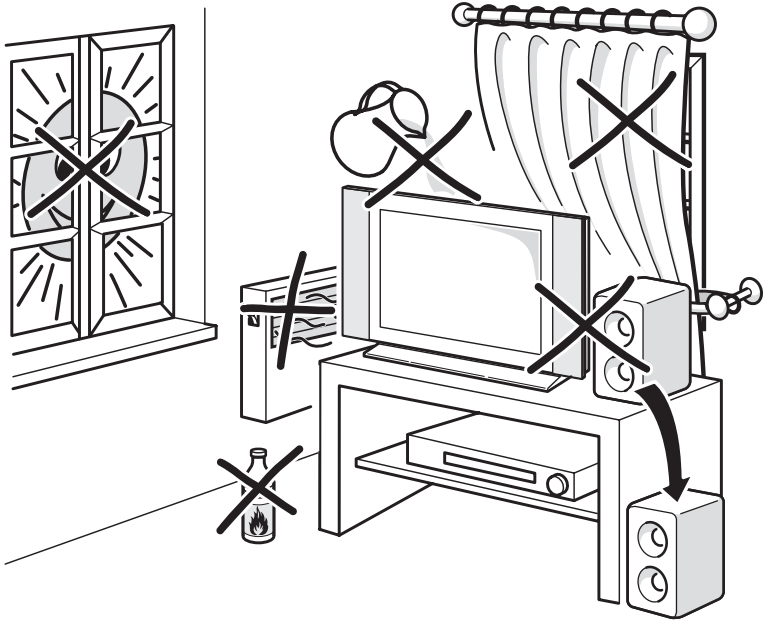

Important information

Safety

Ensure that your domestic mains supply voltage matches the voltage indicated on the identification sticker located at the back of your set. Where the mains plug or an appliance coupler is used as disconnect device, the disconnect device shall remain readily operable.

On certain models, the light indicator is located at the side of the set. The absence of a light indication at the front does not mean that the set is fully disconnected from the mains. To disconnect the set completely, the mains plug must be pulled out.

The set's components are sensitive to heat. The **maximum ambient temperature** should not exceed 35°Celsius. Do not cover the vents at the back or sides of the set. Leave sufficient space around it to allow adequate ventilation. Install the appliance away from any source of heat (fireplace, etc.) or appliances creating strong magnetic or electric fields.

Moisture in rooms where the set is installed should not exceed 85% humidity. Apparatus shall not be **exposed to dripping or splashing and no objects filled with liquids**, such as vases, shall be placed on the apparatus. Moving the set from a cold place to a warm one can cause condensation on the screen (and on some components inside the set). Let the condensation evaporate before switching the set on again.



WARNING

To prevent the spread of fire, keep candles or other open flames away from this product at all times.

The ϕ or POWER/ ϕ button on the set or the ϕ button on the remote control can be used to switch it on and put it into standby mode. If you are not going **to be using the set for a lengthy period of time**, switch it off completely by removing the plug from the mains power socket.

During **thunderstorms**, we recommend that you disconnect the set from the mains and aerial so that it is not affected by electrical or electromagnetic surges that could damage it. For this reason, keep the **mains and aerial sockets** accessible so they can be disconnected, if necessary.

Unplug the set immediately if you notice it giving off a **smell of burning or smoke**. You must never, under any circumstances, open the set yourself, as you run the risk of an **electric shock** in doing so.

LCD screen

The LCD screen used in this product is made of glass. Therefore, it can break when the product is dropped or impacted upon by other objects.

The LCD screen is a very high technology product, giving you finely detailed pictures. Occasionally, a few nonactive pixels may appear on the screen as

a fixed point of blue, green or red. This does not affect the performance of your product.

Care

Use a glass-cleaning product to clean the screen and a soft cloth and mild detergent to clean the rest of the set.

Important: Using strong detergents, alcohol-based and abrasive products may damage the screen.

Dust the vents at the back and sides regularly. Using solvents, abrasive or alcohol-based products could damage the set. If an object or liquid enters the appliance, unplug it immediately and have it checked by an authorized engineer. Never open the appliance yourself since this may put you at risk or damage the appliance.

Hanging the set on the wall

Warning: This operation requires two people.

To ensure a safe installation, observe the following safety notes:

- Check that the wall can support the weight of the set and wall mount assembly.
- Follow the mounting instructions provided with the wall mount. For certain models, make sure to screw the hexagonal VESA wall mounting screw bosses (and screws) provided with the set into the nuts for the wall mount at the back of your set before your wall mounting.
- The set must be installed on a vertical wall.
- Make sure to use only screws suitable for the material of the wall.
- Make sure that the set cables are placed so that there is not danger of tripping over them.

All other safety instructions about our sets are also applicable here.

Handling the set on the table

Before setting up your set, make sure that the surface you want to put the set on can support its weight.

Do not place the set on an unstable surface (e.g. moving shelf, very edge of a unit) and make sure that the front of the set does not overhang the surface it is standing on.



This product is designed and manufactured with high quality materials and components which can be recycled and reused.

This symbol means that electrical and electronic equipment, at their end-of-life, should be disposed of separately from your household waste.

Please, dispose of this equipment at your local community waste collection/recycling centre. In the European Union there are separate collection systems for used electrical and electronic product. Please, help us to conserve the environment we live in!

Buttons on the set

1. **VOLUME UP/DOWN (VOL+/-) button**

Increases/decreases the volume. In the menu system, they act like the right/left direction buttons on the remote and adjust menu controls.

2. **MENU (≡) button**

Brings up the main menu or press to return to the previous menu .

3. **SOURCE (⇄) button**

Press to select signal source.

4. **POWER (⏻) button**

Turns the set on or standby. (Note: for some models, the POWER button turns the set on or off.)

Note: The location and names of the function buttons and power button on the set may vary according to the model.

Sockets

Note: The location and names of the sockets on the set may vary according to the model, and not all sockets available on all models.

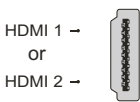

HDMI1 and HDMI2 socket (input)

The HDMI (High-Definition Multimedia Interface) socket can be used to connect a PC with a compatible video card installed, certain DVD players or a high-definition compatible digital satellite decoder. This socket provides an uncompressed digital connection that carries both video and audio data by way of an integrated mini-plug cable.



USB socket (input)

This socket can be used to connect an USB device.

Note: The number of USB sockets on the set may vary according to set model.
This socket is only used to update program.

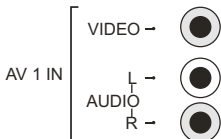

AV 1 RCA audio + video sockets (input)

Note: The **AV 1 IN adapter** socket can be used to connect the attached AV adapter cable with VIDEO and AUDIO L & R IN sockets.

The AV IN sockets can be used to connect a range of equipment, including video recorders, camcorders, decoders, satellite receivers, DVD players, or games consoles. The VIDEO IN1 socket provides composite video connection.



AV adapter (output) socket

Note: The **AV OUT** adapter socket can be used to connect the attached AV adapter cable with VIDEO and AUDIO L & R OUT sockets.

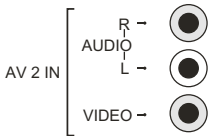

AV 2 RCA audio + video sockets (input)

Note: The AV IN sockets can be used to connect a range of equipment, including video recorders, camcorders, decoders, satellite receivers, DVD players, or games consoles. The VIDEO IN2 socket provides composite video connection.

Note: The audio input port called is shareable for AV 2 IN & COMPONENT IN(YPbPr); Video input port is the same one as Pr/Cr of YPbPr.

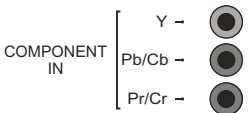

YPbPr component sockets (input)

Note: These YPbPr sockets can be used to connect a device that has component video sockets, such as a DVD player. The component sockets can recognize if the device you're connecting to is Y Pb Pr compatible or Y Cb Cr compatible. The component sockets provide excellent picture quality because the video is separated into three separate parts.



VGA socket (input)

This socket can be used to connect a computer.

Note : Under PC signal source, the audio input port of YPbPr is shareable.

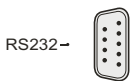

RS232 socket

This socket can be used to control the monitor set.

Remote control functions

Most of your monitor's functions are available via the menus that appear on the screen. The remote control supplied with your set can be used to navigate through the menus and to configure all the general settings.

 Standby / quit standby

 To return to the previous channel

buttons To enter a letter.
Alphanumeric a digit or a symbol in some functions.

EXIT To exit the menu structure .

SOURCE To select connected devices.

FORMAT To select the picture format .

V+/- To control the volume.

PRESETS To select the picture mode .

 To switch the sound off and back on again.

S.EFFECT To select the sound mode .

FREEZE To freeze/unfreeze the picture .

INFO To display programme information, if available.

MENU To access the main menu; to return to the previous menu .

OK To confirm an entry or selection;

▲▼ To navigate through the menus; to select menu options

◀▶ To navigate through the menus;
▶ can also be used to open the corresponding submenu.

* To select the picture format.

Note: You are recommended to use the full screen mode. Do not use the display mode with black bars on both sides of the picture (such as 4:3) for long time; otherwise the screen may be damaged permanently.

Important:

Batteries shall not be exposed to excessive heat such as sunshine, fire or the like. If the batteries in your remote control are run down you can use the buttons on your MONITOR set. In MONITOR mode, they have the same functions as the corresponding buttons on the remote control. In the menus they have the following functions:

For models with OK button on the set:

VOL+,  or **VOL ▶** 
VOL-,  or **VOL ◀** 
MENU or  **MENU**
OK or **SOURCE** **OK**

For models without OK button on the set:

VOL+,  or **VOL ▶** ""
VOL-,  or **VOL ◀** ""
MENU or  **MENU**

Switching on

1. Insert two batteries in the remote control.

Precautions on using batteries:

- Only use the battery types specified.
- Make sure you use the correct polarity.
- Do not mix new and used batteries.
- Do not use rechargeable batteries.
- Do not expose batteries to excessive heat such as sunshine, fire or the like, throw them in a fire, recharge them or try to open them, as this could cause them to leak or explode.
- Remove the batteries from the remote control if you are not using it for a long period of time.

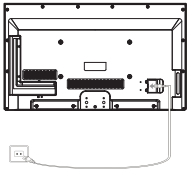

2. Connect the power cable **FIRST** to the monitor, **THEN** to a mains socket.
(Note: If the power cable is connected to the monitor, please only connect the power cable to the mains socket.)

Your set should only be connected to an AC supply. It must not be connected to a DC supply. If the plug is detached from the cable, do not, under any circumstances, connect it to a mains socket, as there is a risk of electric shock.

Note: The figures are for representation only. The location of the power socket at the back of the monitor might differ depending on the model. Switching Off

3. When powered on, the set will be turned on directly or be in standby.
Note: For some models, switch the set on by pressing the power button.

If the power indicator lights up, the set is in standby mode. Press the  button on the remote control or on the set to turn on the monitor.

Switching off

- To put the set into standby mode, press the  button on the remote control or on the model, the set remains powered up, but with low energy consumption.

- To switch off the set, unplug the mains socket from the mains outlet
Note: For some models, press the power button to switch off the set .

Menu Display

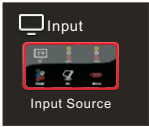

Figure 1

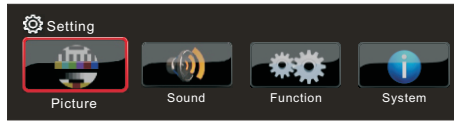

Figure 2

Setting

This main menu contains six submenus, Picture, Sound, Function, System, Auto Show and Geometry.

Use sliding button or press ◀/▶ to toggle among the submenus. Press OK to confirm, and press **MENU** to exit

1. Picture

Press OK to display the menu items of the Picture.

Picture Mode: includes Vivid, Normal, Mild and User. Use sliding button or press ◀/▶ to choose one mode, and press OK to confirm.

Backlight: 0 ~ 100

Brightness: 0 ~ 100

Contrast: 0 ~ 100

Chroma: 0 ~ 100

Sharpness: 0 ~ 100

Tint: 0 ~ 100 (only available in NTSC system)

Col. Temp: Cool, Warm, Medium.

Natural Light: On, Off.

DCC: On, Off.

Picture Size: Normal, Full, Zoom, Expand, Cinema, Subtitle, Native, Dot By Dot. (Note: Some modes are not optional under certain sources.)

2. Sound

Press OK to access option items of the **Sound**.

Sound Mode: Normal, Music, Cinema, News.

Balance: -50 ~ +50

Auto Volume: On, Off.

Scene: HangUp Mode, DeskTop Mode.

3. Function

AIS : Press OK to enter. Use sliding button or press ▲/▼ to select Off, Auto switch, or Manual switch.

Dyn. Comp: Off, On. (Note: this function is not available in certain models.)

Start Logo: Press OK to enter into it. Use sliding button or press ▲/▼ to select Default, Picture 1, or Picture 2. (Note: this function is not available in certain models.)

Start Music off : Default, Music 1.

Language: English.

Color System: Auto, PAL, NTSC, SECAM.

Note: this function is only available under AV source.

Sleep Timer: Off, 5 min, 10min, 20 min, 30 min, 45 min, 60 min, 90 min, 120 min.

off time Setting:

-Current Time: Press OK and a number keyboard appears on the screen. Press ◀/▶ to choose numbers, and press OK to confirm. To delete the inputted numbers, press DEL on the soft keyboard. Press Finished on the soft keyboard to save what you have inputted.

-Power Off Style : Once, Every Day, Off.

-Off Time: the operation method is the same as **Current Time**.

SW Update: Press OK and use sliding button or Press ▲/▼ to update the software(SW) by USB. After the SW updating file is searched, the system automatically begin to update SW.

Restore to Default : Press OK to enter, a prompt "Does restore to factory default?" will turn up. Choose Yes to restore factory default settings.

No Signal standly: On, Off

4. System

System : to display Software Version, User ID (only for those models with network functions).

5. Auto Show

Select Setting > Auto Show, and press OK to enter.

It contains Colour Demo, Grada Demo, Light Demo, and Noise Demo.

Note: This function is not available under VGA source.

6. Geometry

Select Setting > Geometry, and press ▲/▼ to select Auto Adjust, H-Position, V-Position, Clock, and Phase.

Note: Geometry is only available under PC source.